

Servo motors EMMT-AS

FESTO

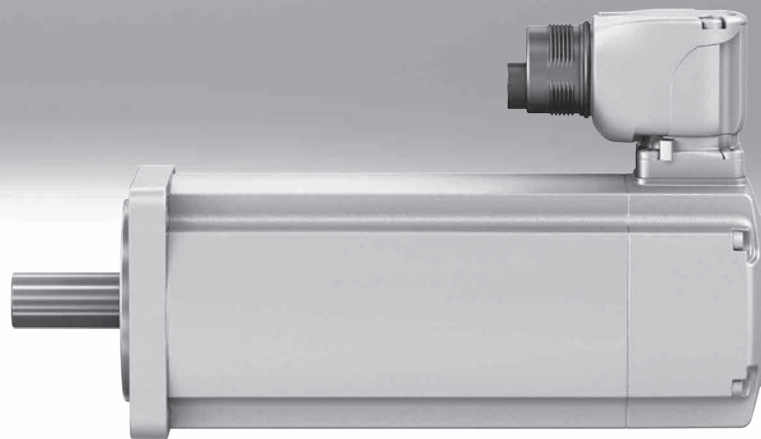

Key features

Everything from a single source

Motors EMMT-AS

→ Page 3



- Dynamic, brushless, permanently excited synchronous servo motors
- Extremely low cogging torque – supports high synchronisation even at low rotational speeds
- Digital absolute displacement encoder; choose from:
 - Single-turn
 - Multi-turn, no batteries
- Motor temperature transmission, digital via EnDat 2.2; motor protection via CMMT-AS
- Optimised torque
- Speed-optimised
- Degree of protection:
 - IP40 (motor shaft)
 - IP67 (motor housing with connection technology)
 - IP65 (motor shaft with rotary shaft seal made from PTFE)
- Optional:
 - Holding brake
 - Shaft with featherkey
 - Motor shaft with rotary shaft seal
- Simple connection technology (OCP: one cable plug) – hybrid cable: motor and connecting cable for supply and encoder rolled into one
- Plug is rotatable:
 - page 14



Gear unit EMGA-EAS/-SAS

→ Page 18



- Low-backlash planetary gear
- Gear ratio $i = 3$ and 5 , available from stock
- Life-time lubrication
- Degree of protection: IP54
- Other gear unit types, ratios, designs and versions on request

Servo drive CMMT-AS

→ Internet: cmmt-as



- Universal servo drive for synchronous servo motors
- Integrated EMC filters
- Integrated brake chopper
- Integrated braking resistor
- Integrated safety functions
- Position controller
- Speed controller
- Force controller
- Range of control functions
- Interfaces:
 - EtherCAT
 - PROFINET RT/IRT
 - EtherNet/IP
 - Modbus TCP

Motor cables NEBM

→ Page 19



- Suitable for energy chains
- Connection technology on motor side with degree of protection to IP67
- Can be used in a wide temperature range

Axial and parallel kits EAMM

→ Internet: eamm



- Specific kits for all electromechanical axes from Festo
- Each kit includes the relevant necessary coupling housing, couplings and motor flange as well as all screws
- Optionally with degree of protection IP65

Type codes

001	Series	
EMMT	Servo motor	

002	Motor type	
AS	AC synchronous	

003	Flange size, motors	
60	60	
80	80	
100	100	

004	Length	
S	Short	
M	Centre	
L	Long	
H	Very long	

005	Output shaft	
	Smooth shaft	
K	Shaft to DIN 6885	

006	Rotary shaft seal	
	None	
R	With standard shaft sealing ring	

007	Winding	
LS	Low voltage, standard	
HS	High voltage, standard	

008	Electrical connection	
R	Angled connector, adjustable	

009	Measuring unit	
S	Absolute encoder, single turn	
M	Absolute encoder, multi-turn	

010	Brake	
	None	
B	With brake	

Data sheet



Note
Motors and motor controllers from Festo have been specially designed to be used together. Trouble-free operation cannot be guaranteed in combination with third-party controllers.



Technical data							
Flange size		60					
Overall length		S		M		L	
Winding		LS	HS	LS	HS	LS	HS
Nominal operating voltage ¹⁾	[V DC]	325	565	325	565	325	565
Nominal current ²⁾	[A]	1.6/1.4	1.6/1.4	2.4/2.2	2.4/2.2	3.2/3	3.2/3
Continuous stall current ²⁾	[A]	1.7/1.6	1.7/1.6	2.7/2.5	2.7/2.5	3.8/3.5	3.8/3.5
Peak current	[A]	5.4	5.4	11.0	11.0	18.3	18.3
Nominal power ²⁾	[W]	200/190	200/190	350/310	350/310	440/410	440/410
Nominal torque ²⁾³⁾	[Nm]	0.64/0.6	0.64/0.6	1.1/1.0	1.1/1.0	1.4/1.3	1.4/1.3
Peak torque	[Nm]	1.6	1.6	3.4	3.4	5.6	5.6
Stall torque ²⁾	[Nm]	0.7/0.66	0.7/0.66	1.24/1.15	1.24/1.15	1.66/1.56	1.66/1.56
Stall torque constant ⁴⁾	[Nm/A]	0.49	0.49	0.53	0.53	0.52	0.52
Nominal rotational speed	[rpm]	3000					
Max. rotational speed	[rpm]	7100	12500	6800	11800	6800	11900
Max. mechanical rotational speed	[rpm]	16000					
Max. idling rotational speed with brake	[rpm]	10000					
Motor constant	[Nm/A]	0.41	0.41	0.45	0.45	0.44	0.44
Voltage constant (phase-to-phase)	[mV/min]	29.9	29.9	32	32	31.2	31.2
Electric time constant	[ms]	2.1	2.1	2.7	2.7	3	3
Number of pole pairs		5	5	5	5	5	5
Winding resistance (phase-to-phase)	[Ω]	11.7	11.7	4.85	4.85	2.68	2.68
Winding inductance (phase-to-phase)	[mH]	38	38	20	20	12	12
Winding series inductance Ld (phase)	[mH]	15.5	15.5	8	8	5	5
Winding shunt inductance Lq (phase)	[mH]	19	19	10	10	6	6
Total output moment of inertia ²⁾	[kgcm ²]	0.169/0.257	0.169/0.257	0.286/0.373	0.286/0.373	0.403/0.490	0.403/0.490
Shaft load at nominal rotational speed							
Radial	[N]	350					
Axial	[N]	65					
Brake							
Operating voltage	[V DC]	24 (+6 ... -10%)					
Current consumption	[A]	0.46					
Power	[W]	11					
Holding torque (static)	[Nm]	2.5					
Separation time	[ms]	≤ 35					
Closing time	[ms]	10					
Response delay	[ms]	≤ 2					
Coil resistance	[Ω]	52.4					
Coil inductance	[mH]	700					
Mass moment of inertia	[kgcm ²]	0.074					
Max. friction work	[J]	5600					

1) With 3-phase mains supply to the servo drive, a voltage up to 3x 400 V AC +10% is permitted
 2) Without brake/with brake
 3) When using the rotary shaft seal, a reduction (derating) of the nominal torque of 10% must be taken into account
 4) Inner stall torque constant

Data sheet

Technical data								
Flange size		80						
Overall length		S		M		L		H
Winding		LS	HS	LS	HS	LS	HS	HS
Nominal operating voltage ¹⁾	[V DC]	325	565	325	565	325	565	565
Nominal current	[A]	2.7	1.76	4.1	2.2	5.5	3.5	3.8
Continuous stall current	[A]	3.1	2	4.9	2.6	6.7	4.3	4.8
Peak current	[A]	8.4	5.4	17.1	9	27.3	17.5	21.7
Nominal power	[W]	408	408	690	690	910	910	1070
Nominal torque ³⁾	[Nm]	1.3	1.3	2.2	2.2	2.9	2.9	3.4
Peak torque	[Nm]	2.8	2.8	6.4	6.4	9.9	9.9	13.5
Stall torque	[Nm]	1.46	1.46	2.6	2.6	3.5	3.5	4.3
Stall torque constant ⁴⁾	[Nm/A]	0.57	0.89	0.62	1.17	0.6	0.93	1
Nominal rotational speed	[rpm]	3000						
Max. rotational speed	[rpm]	6700	7440	6150	5650	6400	7100	6500
Max. mechanical rotational speed	[rpm]	14000						
Max. idling rotational speed with brake	[rpm]	10000						
Motor constant	[Nm/A]	0.48	0.74	0.54	1	0.53	0.82	0.9
Voltage constant (phase-to-phase)	[mVmin]	34.3	53.6	37.3	70.7	36	56	61.4
Electric time constant	[ms]	4.9	4.8	6.5	6.4	6.9	7	7.2
Number of pole pairs		5	5	5	5	5	5	5
Winding resistance (phase-to-phase)	[Ω]	4.93	12.4	2.04	7.43	1.13	2.69	2.21
Winding inductance (phase-to-phase)	[mH]	16.3	39.8	8.9	31.8	5.2	12.6	10.7
Winding series inductance L _d (phase)	[mH]	10.2	25	5.4	19.4	3.1	7.5	6.6
Winding shunt inductance L _q (phase)	[mH]	12.2	29.8	6.6	23.8	3.9	9.45	8.0
Total output moment of inertia ²⁾	[kgcm ²]	1.33/1.64	1.33/1.64	1.77/2.07	1.77/2.07	2.21/2.72	2.21/2.72	2.65/3.16
Shaft load at nominal rotational speed								
Radial	[N]	620						
Axial	[N]	120						
Brake								
Operating voltage	[V DC]	24 (+6 ... -10%)						
Current consumption	[A]	0.5	0.5	0.5	0.5	0.63	0.63	0.63
Power	[W]	12	12	12	12	15	15	15
Holding torque (static)	[Nm]	4.5	4.5	4.5	4.5	7	7	7
Separation time	[ms]	≤ 55	≤ 55	≤ 55	≤ 55	≤ 45	≤ 45	≤ 45
Closing time	[ms]	≤ 15	≤ 15	≤ 15	≤ 15	≤ 30	≤ 30	≤ 30
Response delay	[ms]	≤ 3	≤ 3	≤ 3	≤ 3	≤ 4	≤ 4	≤ 4
Coil resistance	[Ω]	48	48	48	48	38.4	38.4	38.4
Coil inductance	[mH]	1000	1000	1000	1000	900	900	900
Mass moment of inertia	[kgcm ²]	0.249	0.249	0.249	0.249	0.459	0.459	0.459
Max. friction work	[J]	8200	8200	8200	8200	12000	12000	12000

1) With 3-phase mains supply to the servo drive, a voltage up to 3x 400 V AC +10% is permitted

2) Without brake/with brake

3) When using the rotary shaft seal, a reduction (derating) of the nominal torque of 10% must be taken into account

4) Inner stall torque constant

Data sheet

Technical data				
Flange size		100		
Overall length		S	M	L
Winding		HS	HS	HS
Nominal operating voltage ¹⁾	[V DC]	565	565	565
Nominal current	[A]	3.5	4.3	4.7/4.3
Continuous stall current ²⁾	[A]	4.4	5.9	7/6.7
Peak current	[A]	13.7	22.1	28.6
Nominal power ²⁾	[W]	1450	1770	2030/1870
Nominal torque ²⁾³⁾	[Nm]	5.1	6.3	7.2/6.6
Peak torque	[Nm]	13.7	22.4	30.5
Stall torque ²⁾	[Nm]	6.3	8.6	10.8/10.4
Stall torque constant ⁴⁾	[Nm/A]	1.67	1.66	1.75
Nominal rotational speed	[rpm]	2700		
Max. rotational speed	[rpm]	3970	3980	3770
Max. mechanical rotational speed	[rpm]	13000		
Max. idling rotational speed with brake	[rpm]	10000		
Motor constant	[Nm/A]	1.45	1.46	1.54
Voltage constant (phase-to-phase)	[mV/min]	101	100	106
Electric time constant	[ms]	14.5	16.6	15.8
Number of pole pairs		5	5	5
Winding resistance (phase-to-phase)	[Ω]	3.35	1.84	1.49
Winding inductance (phase-to-phase)	[mH]	32.4	20.4	15.7
Winding series inductance L _d (phase)	[mH]	17.8	10.2	8.7
Winding shunt inductance L _q (phase)	[mH]	24.3	15.3	11.8
Total output moment of inertia ²⁾	[kgcm ²]	3.15/4.04	4.46/5.34	5.77/8.06
Shaft load at nominal rotational speed				
Radial	[N]	1110		
Axial	[N]	200		
Brake				
Operating voltage	[V DC]	24 (+6 ... -10%)		
Current consumption	[A]	0.75	0.75	1
Power	[W]	18	18	24
Holding torque (static)	[Nm]	11	11	18
Separation time	[ms]	≤ 80		
Closing time	[ms]	≤ 20	≤ 20	≤ 40
Response delay	[ms]	≤ 4	≤ 4	≤ 5
Coil resistance	[Ω]	32	32	24
Coil inductance	[mH]	900	900	900
Mass moment of inertia	[kgcm ²]	0.74	0.74	2.15
Max. friction work	[J]	12000	12000	15000

1) With 3-phase mains supply to the servo drive, a voltage up to 3x 400 V AC +10% is permitted

2) Without brake/with brake

3) When using the rotary shaft seal, a reduction (derating) of the nominal torque of 10% must be taken into account

4) Inner stall torque constant

Data sheet

Weight [kg]										
Flange size	60			80				100		
Overall length	S	M	L	S	M	L	H	S	M	L
Without brake	1.18	1.53	1.91	2.02	2.64	3.29	3.91	5.5	7.1	8.7
With brake	1.50	1.85	2.23	2.72	3.36	4.12	4.75	6.7	8.2	10.1

Operating and environmental conditions										
Flange size	60			80				100		
Overall length	S	M	L	S	M	L	H	S	M	L
Standard	IEC 60034									
Motor type to EN 60034-7	IM B5/IM V1/IM V3									
Degree of protection										
Motor shaft	IP40									
With rotary shaft seal	IP65									
Motor housing incl. connection technology	IP67									
Ambient temperature										
Temperature [°C]	-15 ... +40									
Up to 80°C with derating of ... per degree Celsius ¹⁾	-1.5%	-1.5%	-1.5%	-1.5%	-1.5%	-1.5%	-1.5%	-1.5%	-1.5%	-1.75%/-2.25%
Storage temperature [°C]	-20 ... +70									
Max. winding temperature [°C]	155									
Temperature monitoring	Digital motor temperature transmission via EnDat 2.2									
Rating class to EN 60034-1	S1									
Thermal class to EN 60034-1	F									
Relative humidity [%]	0 ... 90 (non-condensing)									
Thermal time constant ¹⁾ [min]	40/41	41/42	43/44	42	45	48	51	74	73	71
Thermal resistance ¹⁾ [K/W]	1.3/1.5	1.1/1.3	1/1.2	0.95	0.78	0.68	0.65	0.6	0.5	0.46
Concentricity to DIN SPEC 42955	N									
Balance quality	G 2.5									
Pollution degree	2									
Max. setup altitude [m]	4000 (as of 1000 m only with derating of -1.0% per 100 m)									
Storage lifetime under nominal conditions [h]	20000									
Switching cycles of holding brake ²⁾	10 million idle actuations									
CE marking (see declaration of conformity)	To EU Low Voltage Directive To EU EMC Directive ³⁾ To EU RoHS Directive									
Certification	c UL us - Recognized (OL) RCM									
Certificate issuing authority	UL E342973									
Vibration resistance	Transport application test with severity level 2 to FN 942017-4 and EN 60068-2-6									
Shock resistance	Shock test with severity level 2 to FN 942017-5 and EN 60068-2-27									
PWIS conformity	VDMA24364 zone III									
Note on materials	RoHS-compliant									

1) Without brake/with brake

2) Without friction work

3) For information about the area of use, see the EC declaration of conformity at: www.festo.com/sp → Certificates.

If the devices are subject to usage restrictions in residential, commercial or light-industrial environments, further measures for the reduction of the emitted interference may be necessary.

Data sheet

Technical data – Encoder

Measuring unit	Absolute, single-turn	Absolute, multi-turn
Operating voltage [V DC]	5	
Operating voltage range [V DC]	3.6 ... 14	
Protocol	EnDat 2.2, digital channel only, max. cycle rate (CLOCK) ≤ 16 MHz	
Position values per revolution	262144	524288
Measuring principle	Inductive	
Rotor position encoder resolution	18 bits	19 bit
Revolutions	1	4096 revolutions, 12 bits
System accuracy of angle measurement		
Flange size 60 [arcsec]	-120 ... 120	
Flange size 80 [arcsec]	-120 ... 120	
Flange size 100 [arcsec]	-65 ... 65	

Pin allocation – Motor side

M23x1, pins, 15-pin

	PIN	Function
<p>The diagram shows a circular 15-pin connector layout. Pins 1 through 10 are arranged in a circle around a central hub. Pin 1 is at the top, pin 2 is at the top-left, pin 3 is at the top-right, pin 4 is at the right, pin 5 is at the bottom-right, pin 6 is at the bottom, pin 7 is at the bottom-left, pin 8 is at the left, pin 9 is at the top-left, and pin 10 is at the top-right. Terminals A, B, C, and D are located around the perimeter of the connector. Terminal PE is at the bottom center.</p>	1	BR- Brake
	2	-
	3	-
	4	BR+ Brake
	5	Up Encoder power supply
	6	0V Encoder power supply
	7	Data + Encoder communication
	8	Data - Encoder communication
	9	CLK + Encoder communication
	10	CLK - Encoder communication
	A	U Motor power supply
	B	V Motor power supply
	C	W Motor power supply
	D	-
	PE	PE Protective earth conductor

Data sheet

Torque M as a function of rotational speed n

Flange size 60

Length S

Winding LS (without brake)

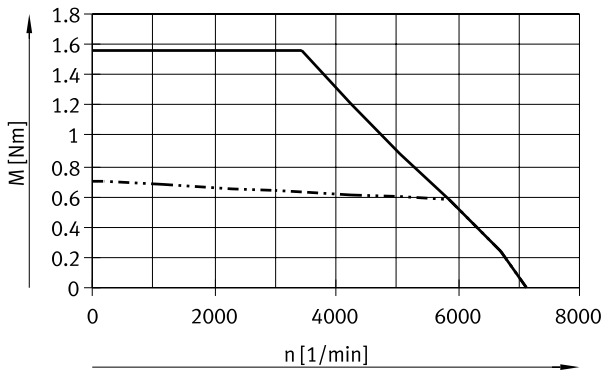

Winding LS-B (with brake)

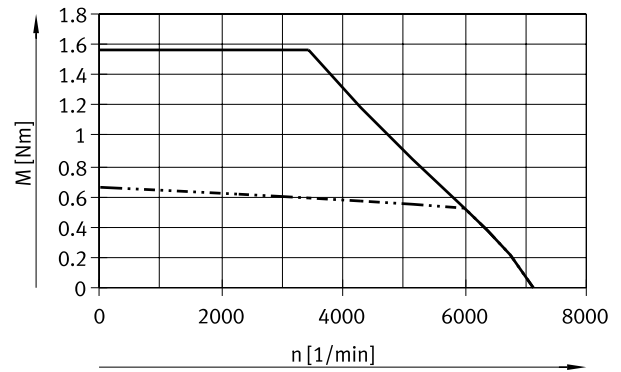

Winding HS (without brake)

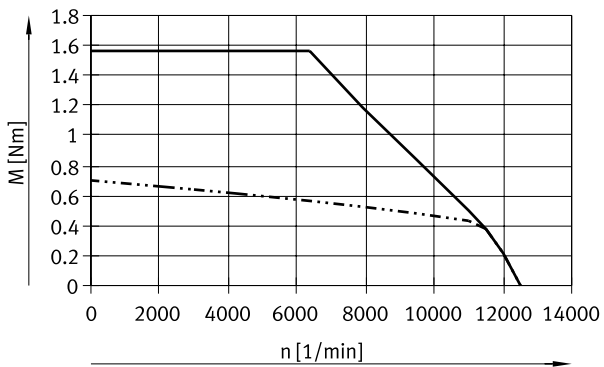

Winding HS-B (with brake)

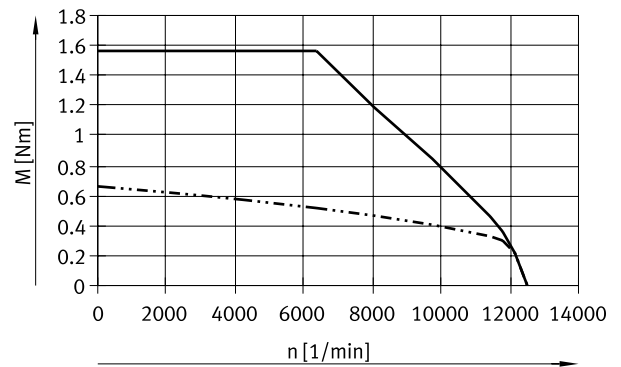

Length M

Winding LS (without brake)

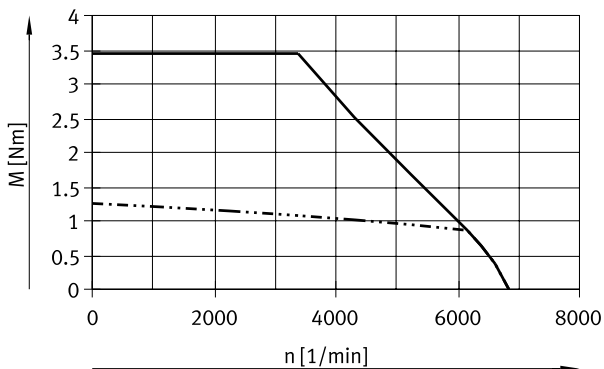

Winding LS-B (with brake)

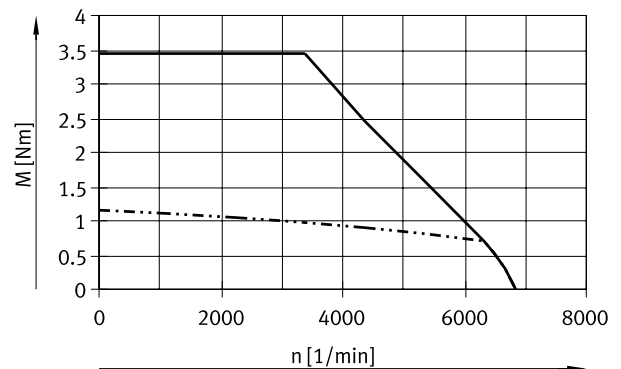

- Peak torque
- · · · · · Nominal torque

Note

Typical motor characteristic curve with nominal voltage and optimal motor controller.
Observe the maximum permissible rotational speeds of add-on and installation components (such as brake, encoder, etc.).

Data sheet

Torque M as a function of rotational speed n

Flange size 60

Length M

Winding HS (without brake)

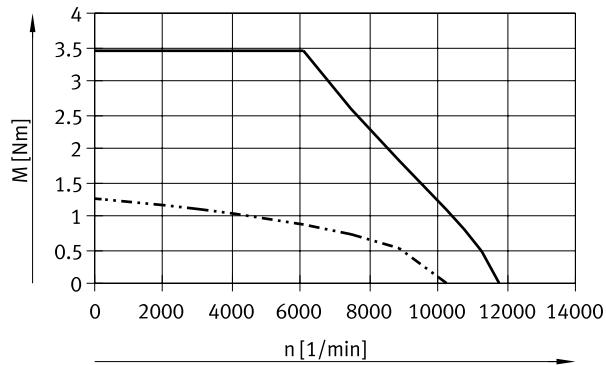

Winding HS-B (with brake)

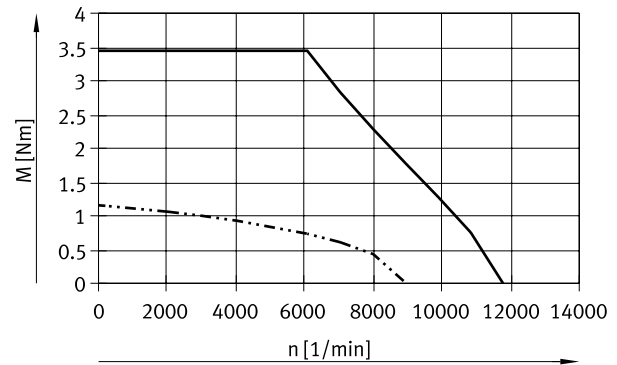

Length L

Winding LS (without brake)

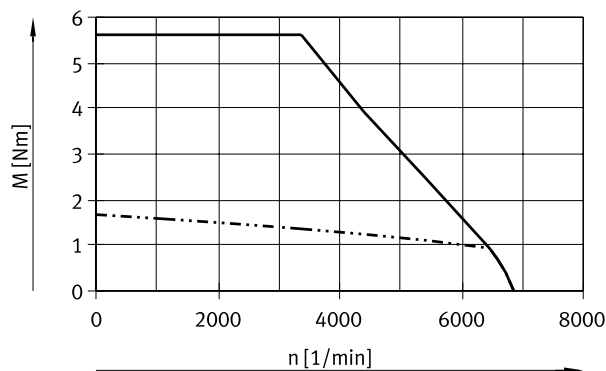

Winding LS-B (with brake)

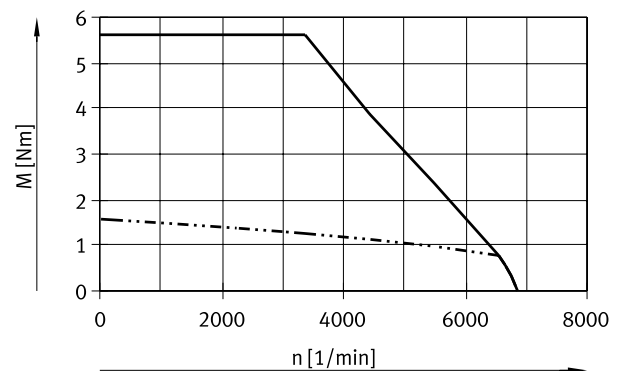

Winding HS (without brake)

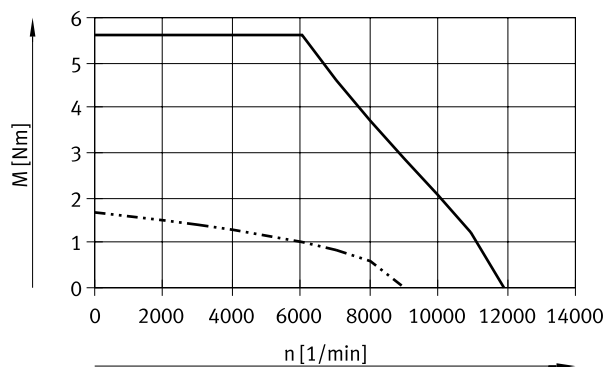

Winding HS-B (with brake)

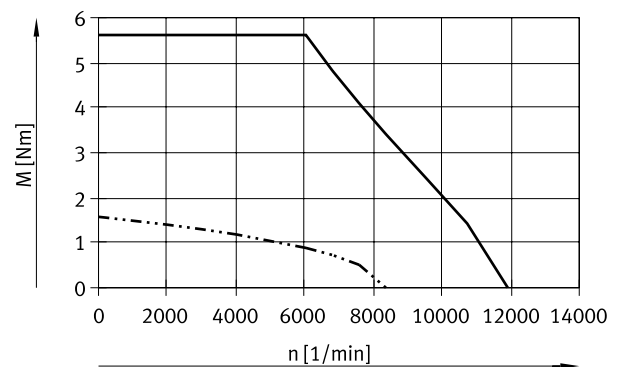

- Peak torque
- - - - - Nominal torque

Note
 Typical motor characteristic curve with nominal voltage and optimal motor controller.
 Observe the maximum permissible rotational speeds of add-on and installation components (such as brake, encoder, etc.).

Data sheet

Torque M as a function of rotational speed n

Flange size 80

Length S

Winding LS (without/with brake)

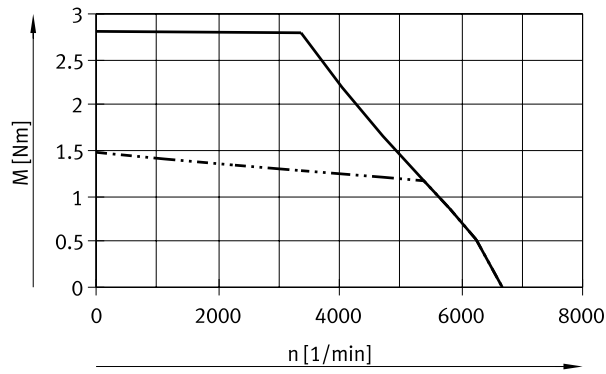

Winding HS (without/with brake)

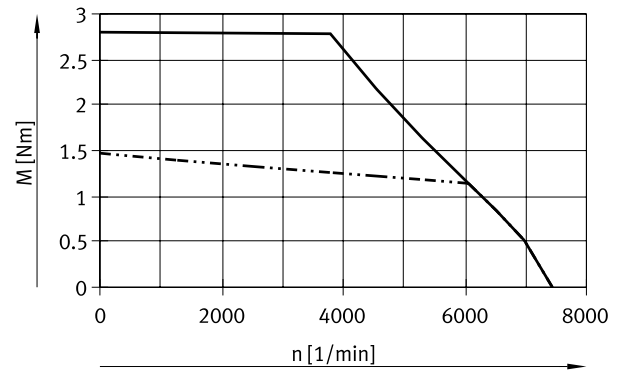

Length M

Winding LS (without/with brake)

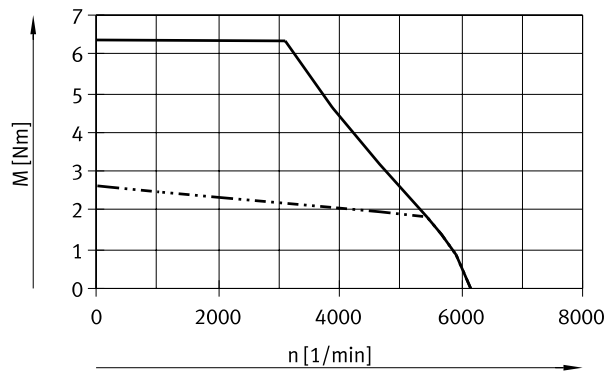

Winding HS (without/with brake)

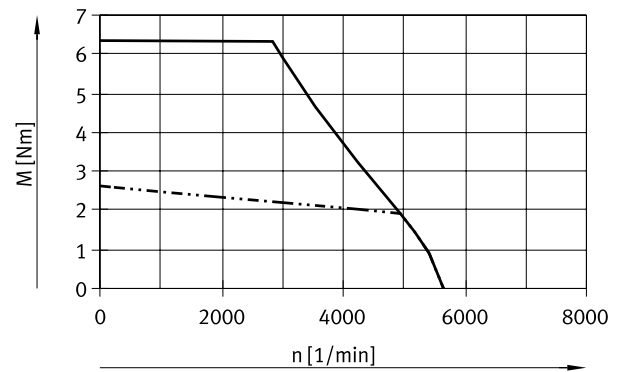

Length L

Winding LS (without/with brake)

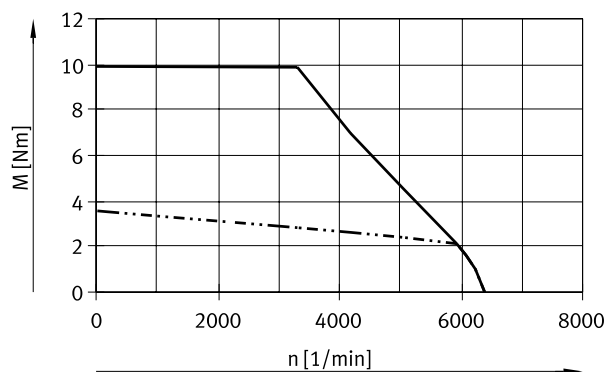

Winding HS (without/with brake)

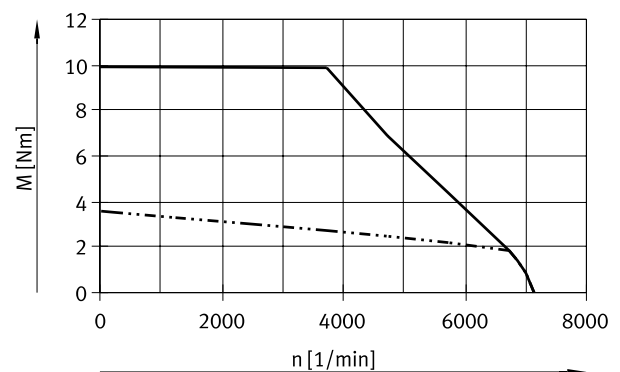

— Peak torque
 - - - - - Nominal torque

Note

Typical motor characteristic curve with nominal voltage and optimal motor controller.

Observe the maximum permissible rotational speeds of add-on and installation components (such as brake, encoder, etc.).

Data sheet

Torque M as a function of rotational speed n

Flange size 80

Length H

Winding HS (without/with brake)

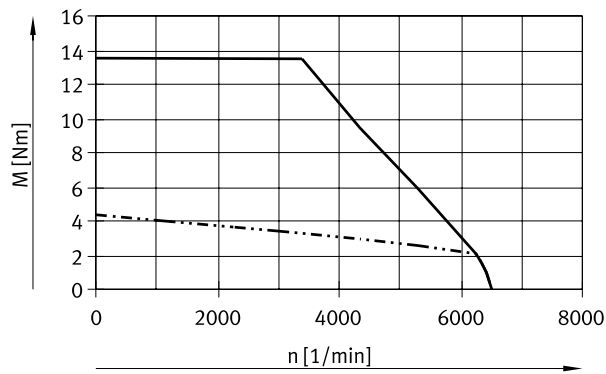

Flange size 100

Length S

Winding HS (without/with brake)

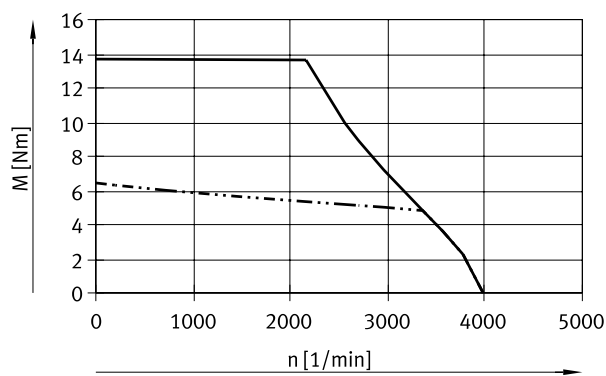

Length M

Winding HS (without/with brake)

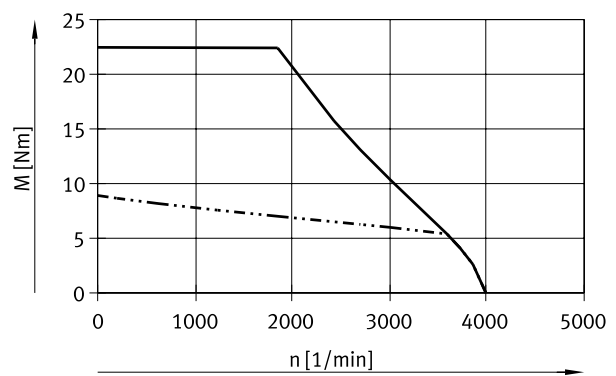

Length L

Winding HS (without brake)

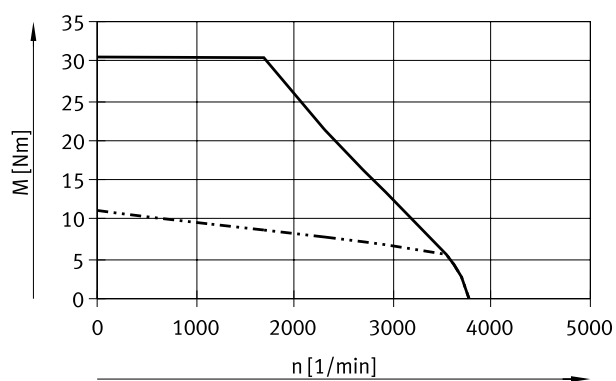

Winding HS-B (with brake)

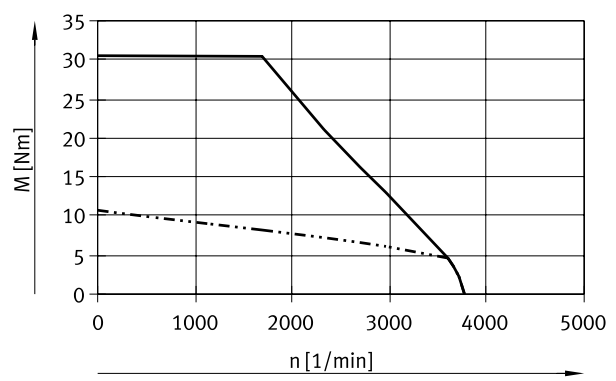

— Peak torque
 - · - · - Nominal torque

Data sheet

Dimensions

Download CAD data → www.festo.com

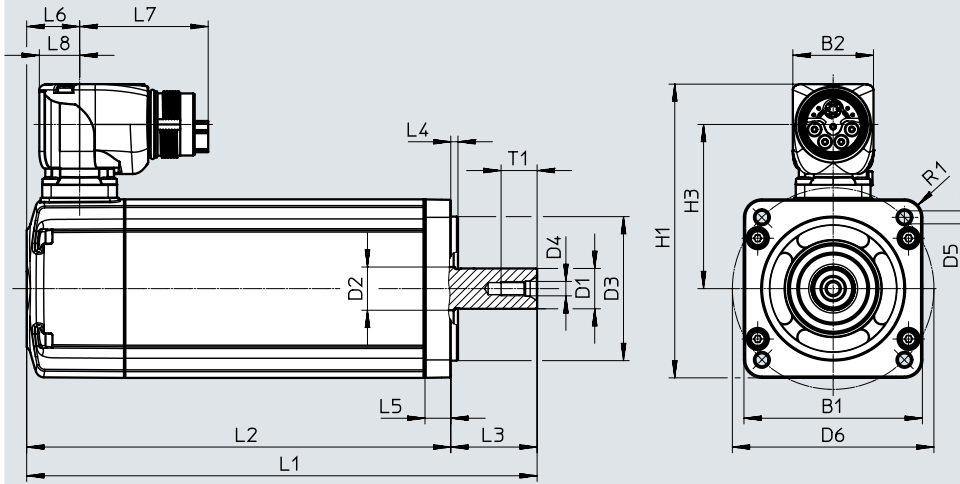

	Overall length	B1	B2	D1 ∅ h6	D2 ∅	D3 ∅ h7	D4	D5 ∅	D6 ∅ ±0.3	H1	H3	L1	
													With brake
60	S	62	28	14	15	50	M5	4.3	70	102	57	144.5	177.3
	M											164.5	197.3
	L											184.5	217.3
80	S	82	28	19	20	70	M6	5.3	90	122	67	165.2	209.4
	M											185.2	229.4
	L											205.2	249.4
	H											225.2	269.4
100	S	104	28	19	20	95	M6	9	115	144	78	227.5	271.7
	M											257.5	301.7
	L											287.5	330.7

	Overall length	L2		L3	L4	L5	L6	L7	L8	R1	T1
		±2	With brake ±2								
60	S	114.5	147.3	30 ^{+0.5/-0.2}	2.5	9	18.4	44.7	14	6	12.5
	M	134.5	167.3								
	L	154.5	187.3								
80	S	130.2	174.4	35 ^{+0.4/-0.2}	3	10	20.1	44.7	14	8	16
	M	150.2	194.4								
	L	170.2	214.4								
	H	190.2	234.4								
100	S	187.5	231.7	40 ^{+0.4/-0.2}	3	12	22.7	44.7	14	11	16
	M	217.5	261.7								
	L	247.5	290.7								

Note

Only motors without featherkey may be used in combination with parallel and axial kits (EAMM-U/EAMM-A).

Data sheet

Dimensions – Featherkey (optional)

Download CAD data → www.festo.com

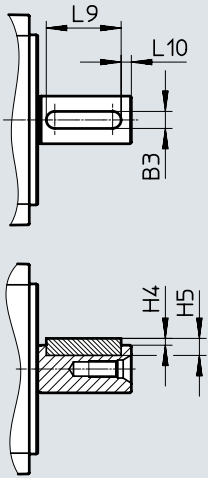

	B3	H4	H5	L9	L10	Featherkey
EMMT-AS-60-...-K	7.5	2	5	22	3	DIN 6885 A 5x5x22
EMMT-AS-80-...-K	8.5	2.5	6	22	3	DIN 6885 A 6x6x22
EMMT-AS-100-...-K	8.5	2.5	6	32	3	DIN 6885 A 6x6x32

Dimensions – Connection

Download CAD data → www.festo.com

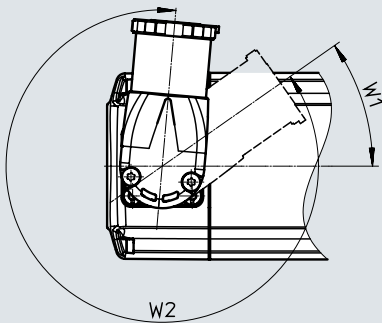

	W1	W2
EMMT-AS-...	-35°	310°

Data sheet

Ordering data			Winding		Measuring unit		Brake	Part no.	Type
Overall length			Low voltage, standard	High voltage, standard	Encoder, single-turn	Encoder, multi-turn			
Short	Medium	Long							
Flange size 60									
■			■		■			5242196	EMMT-AS-60-S-LS-RS
■			■			■		5242197	EMMT-AS-60-S-LS-RM
■			■				■	5242198	EMMT-AS-60-S-LS-RSB
■			■			■	■	5242199	EMMT-AS-60-S-LS-RMB
■				■	■			5242200	EMMT-AS-60-S-HS-RS
■				■		■		5242201	EMMT-AS-60-S-HS-RM
■				■	■		■	5242202	EMMT-AS-60-S-HS-RSB
■				■		■	■	5242203	EMMT-AS-60-S-HS-RMB
	■		■		■			5242204	EMMT-AS-60-M-LS-RS
	■		■			■		5242205	EMMT-AS-60-M-LS-RM
	■		■				■	5242206	EMMT-AS-60-M-LS-RSB
	■		■			■	■	5242207	EMMT-AS-60-M-LS-RMB
	■			■	■			5242208	EMMT-AS-60-M-HS-RS
	■			■		■		5242209	EMMT-AS-60-M-HS-RM
	■			■	■		■	5242210	EMMT-AS-60-M-HS-RSB
	■			■		■	■	5242211	EMMT-AS-60-M-HS-RMB
		■	■		■			5242212	EMMT-AS-60-L-LS-RS
		■	■			■		5242213	EMMT-AS-60-L-LS-RM
		■	■				■	5242214	EMMT-AS-60-L-LS-RSB
		■	■			■	■	5242215	EMMT-AS-60-L-LS-RMB
		■		■	■			5242216	EMMT-AS-60-L-HS-RS
		■		■		■		5242217	EMMT-AS-60-L-HS-RM
		■		■	■		■	5242218	EMMT-AS-60-L-HS-RSB
		■		■		■	■	5242219	EMMT-AS-60-L-HS-RMB
Flange size 80									
■			■		■			5255425	EMMT-AS-80-S-LS-RS
■			■			■		5255426	EMMT-AS-80-S-LS-RM
■			■				■	5255427	EMMT-AS-80-S-LS-RSB
■			■			■	■	5255428	EMMT-AS-80-S-LS-RMB
■				■	■			5255429	EMMT-AS-80-S-HS-RS
■				■		■		5255430	EMMT-AS-80-S-HS-RM
■				■	■		■	5255431	EMMT-AS-80-S-HS-RSB
■				■		■	■	5255432	EMMT-AS-80-S-HS-RSM
	■		■		■			5255433	EMMT-AS-80-M-LS-RS
	■		■			■		5255434	EMMT-AS-80-M-LS-RM
	■		■				■	5255435	EMMT-AS-80-M-LS-RSB
	■		■			■	■	5255436	EMMT-AS-80-M-LS-RMB
	■			■	■			5255437	EMMT-AS-80-M-HS-RS
	■			■		■		5255438	EMMT-AS-80-M-HS-RM
	■			■	■		■	5255439	EMMT-AS-80-M-HS-RSB
	■			■		■	■	5255440	EMMT-AS-80-M-HS-RMB
		■	■		■			5255441	EMMT-AS-80-L-LS-RS
		■	■			■		5255442	EMMT-AS-80-L-LS-RM
		■	■				■	5255443	EMMT-AS-80-L-LS-RSB
		■	■			■	■	5255444	EMMT-AS-80-L-LS-RMB
		■		■	■			5255445	EMMT-AS-80-L-HS-RS
		■		■		■		5255446	EMMT-AS-80-L-HS-RM
		■		■	■		■	5255447	EMMT-AS-80-L-HS-RSB
		■		■		■	■	5255448	EMMT-AS-80-L-HS-RMB

Data sheet

Ordering data									
Overall length			Winding		Measuring unit		Brake	Part no.	Type
Short	Medium	Long	Low voltage, standard	High voltage, standard	Encoder, single-turn	Encoder, multi-turn			
Flange size 100									
■				■	■			5255519	EMMT-AS-100-S-HS-RS
■				■		■		5255521	EMMT-AS-100-S-HS-RM
■				■	■		■	5255528	EMMT-AS-100-S-HS-RSB
■				■		■	■	5255529	EMMT-AS-100-S-HS-RMB
	■			■	■			5255530	EMMT-AS-100-M-HS-RS
	■			■		■		5255531	EMMT-AS-100-M-HS-RM
	■			■	■		■	5255532	EMMT-AS-100-M-HS-RSB
	■			■		■	■	5255533	EMMT-AS-100-M-HS-RMB
		■		■	■			5255534	EMMT-AS-100-L-HS-RS
		■		■		■		5255535	EMMT-AS-100-L-HS-RM
		■		■	■		■	5255536	EMMT-AS-100-L-HS-RSB
		■		■		■	■	5255537	EMMT-AS-100-L-HS-RMB

Ordering data – Modular product system

Ordering table						
Size	60	80	100	Conditions	Code	Enter code
Module no.	4808568	4595815	5185818			
Series	EMMT				EMMT	EMMT
Motor technology	AC synchronous				-AS	-AS
Motor flange size	60 mm	80	100		-	-
Overall length	Short				-S	
	Medium				-M	
	Long				-L	
	Very long				-H	
Output shaft	Smooth shaft					
	Shaft to DIN 6885				K	
Rotary shaft seal	None					
	With standard shaft seal			[1]	R	
Winding	Low voltage, standard			[2]	-LS	
	High voltage, standard				-HS	
Electrical connection	Angled plug, rotatable				-R	-R
Measuring unit	Absolute encoder, single-turn				S	
	Absolute encoder, multi-turn				M	
Brake	None					
	With brake				B	

[1] R When using the rotary shaft seal, a reduction (derating) of the nominal torque of 10% must be taken into account

[2] LS Not in combination with length H

Accessories

Ordering data – Gear unit

Data sheets → Internet: emga

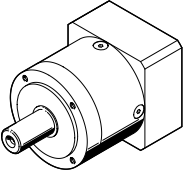
	Motor interface	Gear ratio	Part no.	Type
	60P	3	2297686	EMGA-60-P-G3-EAS-60
		5	2297687	EMGA-60-P-G5-EAS-60
	80P	3	2297690	EMGA-80-P-G3-EAS-80
		5	2297691	EMGA-80-P-G5-EAS-80
	100A	3	552194	EMGA-80-P-G3-SAS-100
		5	552195	EMGA-80-P-G5-SAS-100
		3	552196	EMGA-120-P-G3-SAS-100
		5	552197	EMGA-120-P-G5-SAS-100





Ordering data – Rotary shaft seal

	For flange size	Description	Part no.	Type
	60	<ul style="list-style-type: none"> • For the motors EMMT-AS • Protection to IP65 is achieved in combination with the sealing ring • Based on the operating conditions, the shaft seal must be replaced after a maximum of 5000 operating hours • When using the rotary shaft seal, a reduction (derating) of the nominal torque of 10% must be taken into account • Information on installation/replacement → www.festo.com/sp 	8079786	EASS-RS-T-A-4P-15-30-B7
	80, 100		8079785	EASS-RS-T-A-4P-20-40-B7

Accessories

Recommended cable cross section at an ambient temperature of 40°C as a function of cable length and servo drive CMMT-AS

	Up to 10 m	Up to 20 m	Up to 30 m	Up to 40 m	Up to 50 m	Up to 75 m	Up to 100 m
EMMT-AS-60-...	0.75 mm ²	0.75 mm ²	0.75 mm ²	1.5 mm ²	1.5 mm ²	2.5 mm ²	2.5 mm ²
EMMT-AS-80-...	0.75 mm ²	0.75 mm ²	0.75 mm ²	1.5 mm ²	1.5 mm ²	2.5 mm ²	2.5 mm ²
EMMT-AS-100-...	0.75 mm ²	0.75 mm ²	0.75 mm ²	1.5 mm ²	1.5 mm ²	2.5 mm ²	2.5 mm ²
EMMT-AS-100-S-HS-...B	0.75 mm ²	0.75 mm ²	0.75 mm ²	1.5 mm ²	1.5 mm ²	2.5 mm ²	2.5 mm ²
EMMT-AS-100-M-HS-...B	0.75 mm ²	0.75 mm ²	0.75 mm ²	1.5 mm ²	1.5 mm ²	2.5 mm ²	2.5 mm ²
EMMT-AS-100-L-HS-...B	0.75 mm ²	0.75 mm ²	0.75 mm ²	1.5 mm ²	1.5 mm ²	2.5 mm ²	2.5 mm ²

	0.75 mm ²
	1.5 mm ²
	2.5 mm ²
	No cable

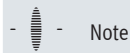

Note

- When using other servo drives, the max. cable lengths may be shorter or the cable cross sections may be different.
- For cable lengths > 25 m, prior technical clarification is recommended.
- Motors with a holding brake require a logic power supply of $U_B \geq 24$ V DC. In this case, the recommended motor cables from Festo with the corresponding cross sections should also be used.
- This recommendation is made on the basis that the servo drive is connected to the supply network via a short connecting cable and network-side voltage drops can therefore be neglected.

Technical data – Motor cables

Cable cross section	0.75 mm ²	1.5 mm ²	2.5 mm ²
Type	NEBM-M23G15-...-Q7N	NEBM-M23G15-...-Q9N	NEBM-M23G15-...-Q10N
Cable composition	4x 0.75 mm ² + 1x (2x 0.75 mm ²) + 1x (2x 0.24 mm ² + 2x 2x 0.15 mm ²) Shielded	4 x 1.5 mm ² + 1 x (2 x 0.75 mm ²) + 1 x (2 x 0.24 mm ² + 2 x 2 x 0.15 mm ²)	4 x 2.5 mm ² + 1 x (2 x 1.0 mm ²) + 1 x (2 x 0.24 mm ² + 2 x 2 x 0.15 mm ²)
Cable diameter [mm]	12	12.8	13.9
Min. bending radius			
For fixed cable installation [mm]	≥ 48	≥ 51.2	≥ 55.6
With flexible cable installation [mm]	≥ 90	≥ 96	≥ 97.3
Pollution degree	1	3	3
Ambient temperature			
For fixed cable installation [°C]	-40 ... +90		
With flexible cable installation [°C]	-25 ... +80		
Cable characteristic	Suitable for energy chains		
Degree of protection	IP67 (in assembled state)		
Material	TPE-U (PUR)		
Note on materials	RoHS-compliant		
CE marking (see declaration of conformity)	To EU Low Voltage Directive		

Accessories

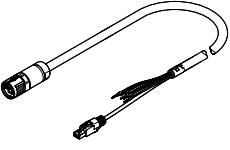
Ordering data – Motor cable				
	Cable cross section	Cable length [m]	Part no.	Type
	0.75 mm ²	2.5	5251374	NEBM-M23G15-EH-2.5-Q7N-R3LEG14
		5	5251375	NEBM-M23G15-EH-5-Q7N-R3LEG14
		7.5	5251376	NEBM-M23G15-EH-7.5-Q7N-R3LEG14
		10	5251377	NEBM-M23G15-EH-10-Q7N-R3LEG14
		15	5251378	NEBM-M23G15-EH-15-Q7N-R3LEG14
		20	5251379	NEBM-M23G15-EH-20-Q7N-R3LEG14
		X length ¹⁾	5251373	NEBM-M23G15-EH-...-Q7N-R3LEG14
	1.5 mm ²	2.5	5251381	NEBM-M23G15-EH-2.5-Q9N-R3LEG14
		5	5251382	NEBM-M23G15-EH-5-Q9N-R3LEG14
		7.5	5251383	NEBM-M23G15-EH-7.5-Q9N-R3LEG14
		10	5251384	NEBM-M23G15-EH-10-Q9N-R3LEG14
		15	5251385	NEBM-M23G15-EH-15-Q9N-R3LEG14
		20	5251386	NEBM-M23G15-EH-20-Q9N-R3LEG14
		X length ¹⁾	5251380	NEBM-M23G15-EH-...-Q9N-R3LEG14
	2.5 mm ²	2.5	5251388	NEBM-M23G15-EH-2.5-Q10N-R3LEG14
		5	5251389	NEBM-M23G15-EH-5-Q10N-R3LEG14
		7.5	5251390	NEBM-M23G15-EH-7.5-Q10N-R3LEG14
		10	5251391	NEBM-M23G15-EH-10-Q10N-R3LEG14
		15	5251392	NEBM-M23G15-EH-15-Q10N-R3LEG14
		20	5251393	NEBM-M23G15-EH-20-Q10N-R3LEG14
		X length ¹⁾	5251387	NEBM-M23G15-EH-...-Q10N-R3LEG14

1) Choice of cable lengths: 0.5 ... 99.9 m, in increments of 0.1 m.

Festo - Your Partner in Automation



1 Festo Inc.
5300 Explorer Drive
Mississauga, ON L4W 5G4
Canada

Festo Customer Interaction Center
Tel: 1 877 463 3786
Fax: 1 877 393 3786
Email: customer.service.ca@festo.com

2 Festo Pneumatic
Av. Ceylán 3,
Col. Tequesquináhuac
54020 Tlalnepantla,
Estado de México

Multinational Contact Center
01 800 337 8669
ventas.mexico@festo.com

3 Festo Corporation
1377 Motor Parkway
Suite 310
Islandia, NY 11749

Festo Customer Interaction Center
1 800 993 3786
1 800 963 3786
customer.service.us@festo.com

4 Regional Service Center
7777 Columbia Road
Mason, OH 45040

Connect with us



www.festo.com/socialmedia



www.festo.com

Subject to change